

1T8989 | OZ Stand Alone Recessed Recessed LED floodlights

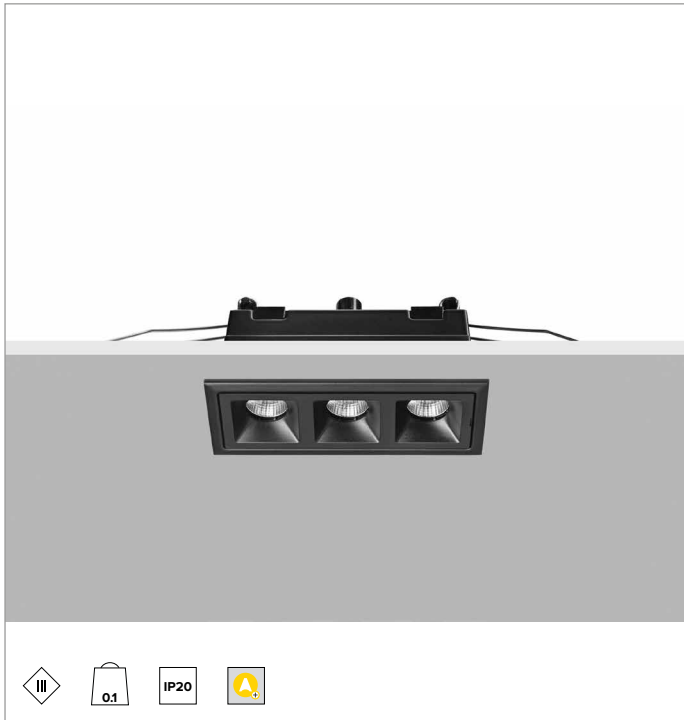

	4000K	H(m)	D1(m)	D2(m)	E _{max} (lx)		
	Ra90	48°	17°				
Fixture Power	5W	1	0.90	0.30	999		
Source Flux	512lm	2	1.80	0.61	250		
Fixture Flux	363lm	3	2.70	0.91	111		
Efficacy	70lm/W	4	3.60	1.22	62		
TS1247	I _{max} =1951cd/klm	I _{max}	999cd	5	4.50	1.52	40

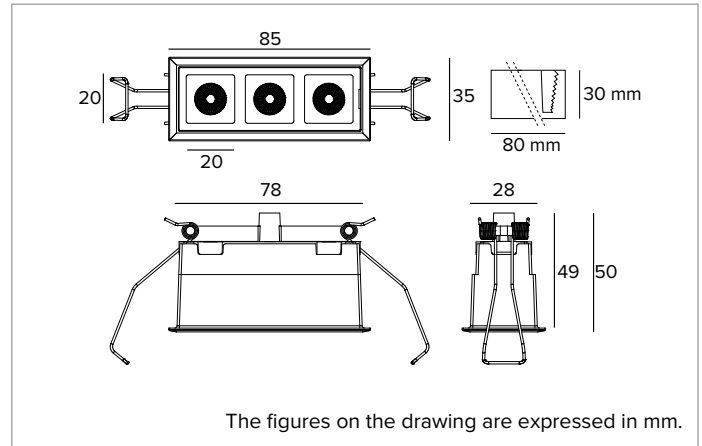

SOURCE

Hugh efficiency Ra90 LED Emitter.

Energy efficiency class: F

Nominal power: 5,2W

Nominal flux: 512lm

Colour rendering index: 90

Rf: 90.9

Rg: 101.1

CCT nominal: 4000K

SDCM: 2

Lifetime (L80/B10): >50000h tq +25°C

ILLUMINOTECHNICAL CHARACTERISTICS

ELL optic. A metallised polycarbonate reflector, a holographic filter and a black polycarbonate frame. The fixture is suitable for installation in workplaces UGR<13/22 (EN12464-1).

Optic: REFLECTOR

Beam angles: ELL

Optical efficiency: 71%

Fixture flux: 363lm

Luminous efficacy: 70lm/W

Photobiological safety: Compliant with RG1 low risk group

MECHANICAL CHARACTERISTICS

Black painted die-cast aluminium body. 3X Small version.

Colour and finish: Deep black

Dimensions: AxB=85x35mm

Weight: 0.1Kg

Version: 3X

Degree of protection: IP20

ELECTRICAL CHARACTERISTICS

To be completed with electronic ON-OFF or DALI driver available as accessory.

Fixture Power: 5W

Power supply: 600mA

Insulation Class: CLASS 3

Driver included: NO

Class F: YES

Ambient temperature: 0°C / +25°C

INSTALLATION

Quick fastening system with springs for installation in false ceilings from 0 to 30mm.

NOTES

Casambi control system available via accessory (only for products with DALI driver). Values related to the power consumption of the fixture do not take into account the consumption of the accessory driver, which depends on the choice of driver. 110-277Vac version available on request. Commissioning of the control system via free APP; the intervention of a specialist technician can be quoted on request.

WARRANTY

5 years.

WARNING

Luminaire designed for disposal/recycling at end-of-life. Replaceable (LED only) light source by a professional.

Due to the technological evolution of the electronic components, the data provided may be updated, and as such, confirmation must be requested during the order process.

Luminous flux and power supply have +/-10% tolerances with respect to the indicated value. tq +25°C (CIE 121).

We reserve the right to make technical changes.

Targetti Sankey S.r.l.
Via Pratese, 164
50145 Firenze - Italy
Tel: +39 055 37911
targetti.com
targetti@targetti.com

CCIAA Firenze
Share Capital:
€ 500.000,00
VAT N. (IT):
01537660480
R.E.A.: FI-275656

TARGETTI

1T8989 | OZ Stand Alone Recessed Recessed LED floodlights

Related codes

Power Supply

Dimensions LxHxP mm	Power	Power supply	Output current	IP	Code	Dimensions LxHxP mm	Power	Power supply	Output current	IP	Code
110x22x52	20W	110-240Vac	600mA	IP20	1T8172EL	156x26x52	20W	230Vac	600mA	IP20	1T8172DA
Electronic ON-OFF power supply.						DALI power supply.					

Accessories

Emergency Kit



Code

A059

Emergency kit composed of an inverter a LiFePO4 battery and a LED Green indicator. Allows permanent EP emergency use of the fixture it is connected to. The 1h or 3h autonomy can be selected by configuring the fixture. The batteries take 12h to completely recharge. LED Green indicator wired to the inverter through single-core cables L= 800mm. Emergency kit for fixtures that comply with EN 60598-2-22 standard, high risk areas excluded. Battery size 160x54x30 mm. Inverter size 165x40x25 mm.

Control systems



Code

1T5349

IP20 wireless control unit with DALI interface. It generates a local DALI2 bus, enabling a direct connection to a DALI interface LED driver. The module can only be used in a closed system and cannot be connected to an existing DALI network. The module is wireless controlled using a Casambi app for smartphones and tablets using Bluetooth 5.0 technology. The devices automatically create an adaptive, robust, and reliable wireless mesh network, allowing for the easy and efficient management of a high number of fixtures. The control unit is preset to the DALI 1CH profile, meaning the device can control a single DALI driver with broadcast commands. In addition to the DALI broadcast, other operating modes are available, such as:

- Button (normally open)
- Control unit 0/1-10V
- Control unit DALI Tunable White DT8
- Presence sensor



Code

2T0131

IP20 Extender for wireless control of LED driver with dimming DALI (or 1-10V) interface based on Casambi technology. It has a DALI2 output with the capacity to control up to 40 lighting fixtures. With the addition of a further external BUS DALI power supply it is possible to control up to 64 fixtures. IP20 Extender is preset to the DALI broadcast profile, meaning all the luminaires connected to it are dimmable at the same level. In addition to the DALI broadcast other operating modes are available, such as:

- EXTENDER DALI 8CH
- EXTENDER DALI Tunable White
- EXTENDER 0/1-10V
- EXTENDER DALI 4CH
- EXTENDER DALI DT8 Tunable White

Due to the technological evolution of the electronic components, the data provided may be updated, and as such, confirmation must be requested during the order process. Luminous flux and power supply have +/-10% tolerances with respect to the indicated value. tq +25°C (CIE 121).

We reserve the right to make technical changes.

Targetti Sankey S.r.l.
Via Pratese, 164
50145 Firenze - Italy
Tel: +39 055 37911
targetti.com
targetti@targetti.com

CCIAA Firenze
Share Capital:
€ 500.000,00
VAT N. (IT):
01537660480
R.E.A.: FI-275656

TARGETTI